

Silicon N_Channel MOSFET Tetrode

- Short-channel transistor with high S / C quality factor
- For low-noise, gain-controlled input stage up to 1 GHz
- Pb-free (RoHS compliant) package¹⁾
- Qualified according AEC Q101

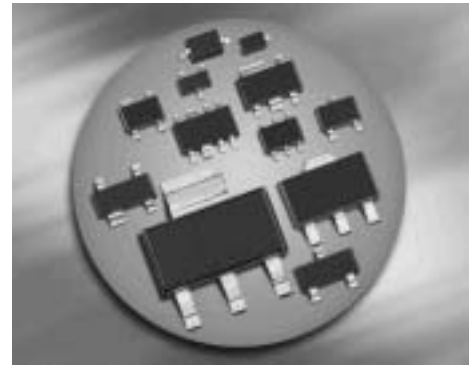

ESD (Electrostatic discharge) sensitive device, observe handling precaution!

Type	Package	Pin Configuration						Marking
BF998	SOT143	1=S	2=D	3=G2	4=G1	-	-	MOs
BF998R	SOT143R	1=D	2=S	3=G1	4=G2	-	-	MRs

Maximum Ratings

Parameter	Symbol	Value	Unit
Drain-source voltage	V_{DS}	12	V
Continuous drain current	I_D	30	mA
Gate 1/ gate 2-source current	$\pm I_{G1/2SM}$	10	
Total power dissipation $T_S \leq 76 \text{ }^\circ\text{C}$, BF998, BF998R	P_{tot}	200	
Storage temperature	T_{stg}	-55 ... 150	$^\circ\text{C}$
Channel temperature	T_{ch}	150	

Thermal Resistance

Parameter	Symbol	Value	Unit
Channel - soldering point ²⁾ , BF998, BF998R	R_{thchs}	≤ 370	K/W

¹⁾Pb-containing package may be available upon special request

²⁾For calculation of R_{thJA} please refer to Application Note Thermal Resistance

Electrical Characteristics at $T_A = 25^\circ\text{C}$, unless otherwise specified

Parameter	Symbol	Values			Unit
		min.	typ.	max.	
DC Characteristics					
Drain-source breakdown voltage $I_D = 10 \mu\text{A}$, $V_{G1S} = -4 \text{ V}$, $V_{G2S} = -4 \text{ V}$	$V_{(BR)DS}$	12	-	-	V
Gate 1 source breakdown voltage $\pm I_{G2S} = 10 \text{ mA}$, $V_{G2S} = V_{DS} = 0$	$\pm V_{(BR)G1SS}$	8	-	12	
Gate2 source breakdown voltage $\pm I_{G2S} = 10 \text{ mA}$, $V_{G2S} = V_{DS} = 0$	$\pm V_{(BR)G2SS}$	8	-	12	
Gate 1 source leakage current $\pm V_{G1S} = 5 \text{ V}$, $V_{G2S} = V_{DS} = 0$	$\pm I_{G1SS}$	-	-	50	nA
Gate 2 source leakage current $\pm V_{G2S} = 5 \text{ V}$, $V_{G2S} = V_{DS} = 0$	$\pm I_{G2SS}$	-	-	50	nA
Drain current $V_{DS} = 8 \text{ V}$, $V_{G1S} = 0$, $V_{G2S} = 4 \text{ V}$	I_{DSS}	5	9	15	mA
Gate 1 source pinch-off voltage $V_{DS} = 8 \text{ V}$, $V_{G2S} = 4 \text{ V}$, $I_D = 20 \mu\text{A}$	$-V_{G1S(p)}$	-	0.8	2.5	V
Gate 2 source pinch-off voltage $V_{DS} = 8 \text{ V}$, $V_{G1S} = 0$, $I_D = 20 \mu\text{A}$	$-V_{G2S(p)}$	-	0.8	2	

Electrical Characteristics at $T_A = 25^\circ\text{C}$, unless otherwise specified

Parameter	Symbol	Values			Unit
		min.	typ.	max.	
AC Characteristics (verified by random sampling)					
Forward transconductance $V_{DS} = 8\text{ V}$, $I_D = 10\text{ mA}$, $V_{G2S} = 4\text{ V}$	g_{fs}	20	24	-	-
Gate1 input capacitance $V_{DS} = 8\text{ V}$, $I_D = 10\text{ mA}$, $V_{G2S} = 4\text{ V}$, $f = 10\text{ MHz}$	C_{g1ss}	-	2.1	2.5	pF
Gate 2 input capacitance $V_{DS} = 8\text{ V}$, $I_D = 10\text{ mA}$, $V_{G2S} = 4\text{ V}$, $f = 10\text{ MHz}$	C_{g2ss}	-	1.2	-	pF
Feedback capacitance $V_{DS} = 8\text{ V}$, $I_D = 10\text{ mA}$, $V_{G2S} = 4\text{ V}$, $f = 10\text{ MHz}$	C_{dg1}	-	25	-	fF
Output capacitance $V_{DS} = 8\text{ V}$, $I_D = 10\text{ mA}$, $V_{G2S} = 4\text{ V}$, $f = 10\text{ MHz}$	C_{dss}	-	1.1	-	pF
Power gain $V_{DS} = 8\text{ V}$, $I_D = 10\text{ mA}$, $V_{G2S} = 4\text{ V}$, $f = 45\text{ MHz}$ $V_{DS} = 8\text{ V}$, $I_D = 10\text{ mA}$, $V_{G2S} = 4\text{ V}$, $f = 800\text{ MHz}$	G_p	-	28	-	dB
		-	20	-	
Noise figure $V_{DS} = 8\text{ V}$, $I_D = 10\text{ mA}$, $V_{G2S} = 4\text{ V}$, $f = 45\text{ MHz}$ $V_{DS} = 8\text{ V}$, $I_D = 10\text{ mA}$, $V_{G2S} = 4\text{ V}$, $f = 800\text{ MHz}$	F	-	2.8	-	dB
		-	1.8	-	
Gain control range $V_{DS} = 8\text{ V}$, $V_{G2S} = 4 \dots -2\text{ V}$, $f = 800\text{ MHz}$	ΔG_p	40	50	-	

Total power dissipation $P_{tot} = f(T_S)$

BF998, BF998R

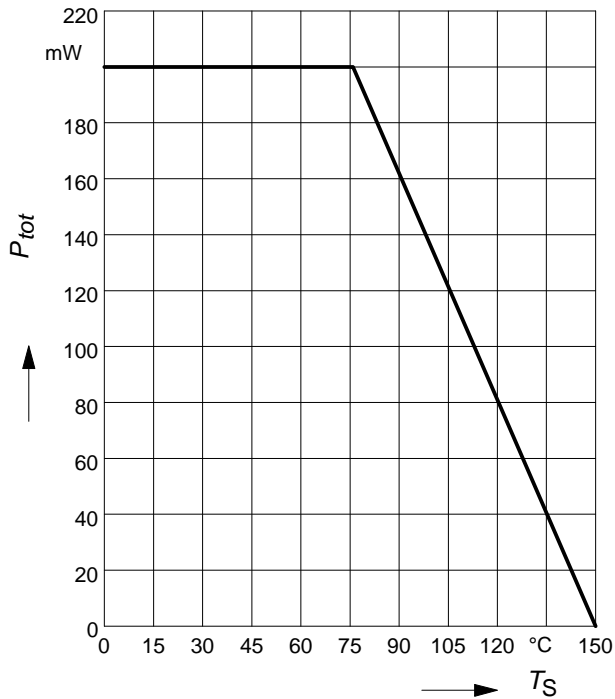
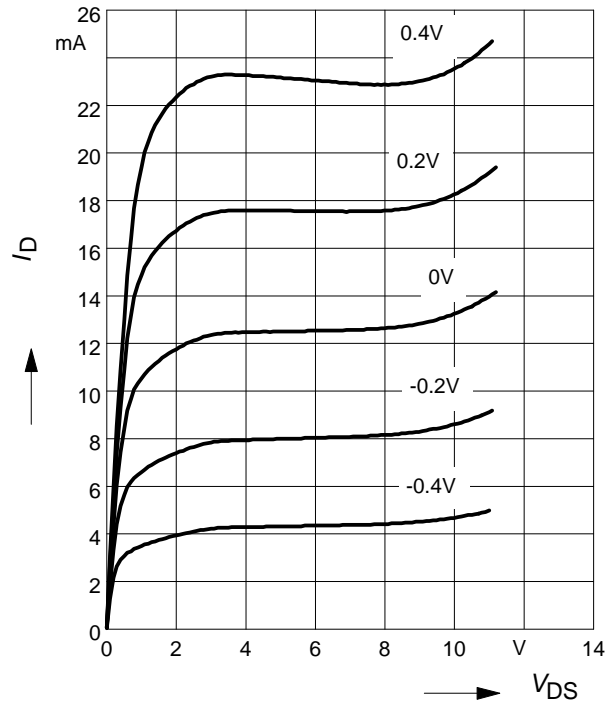
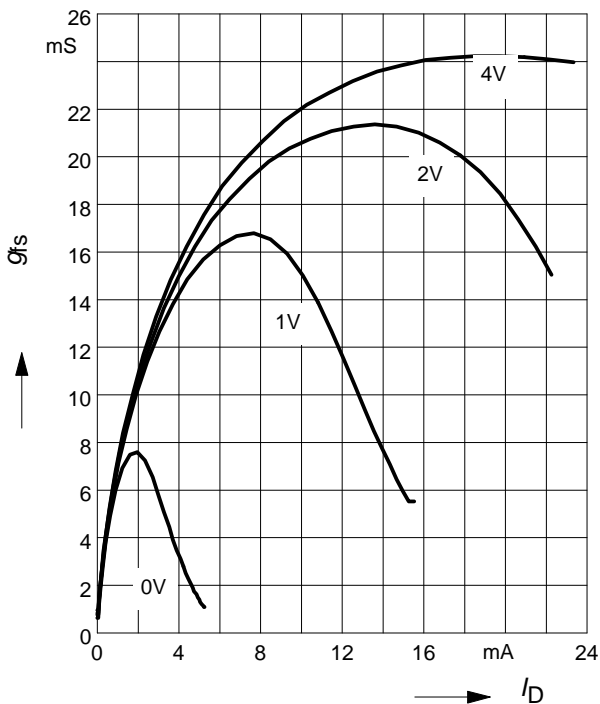
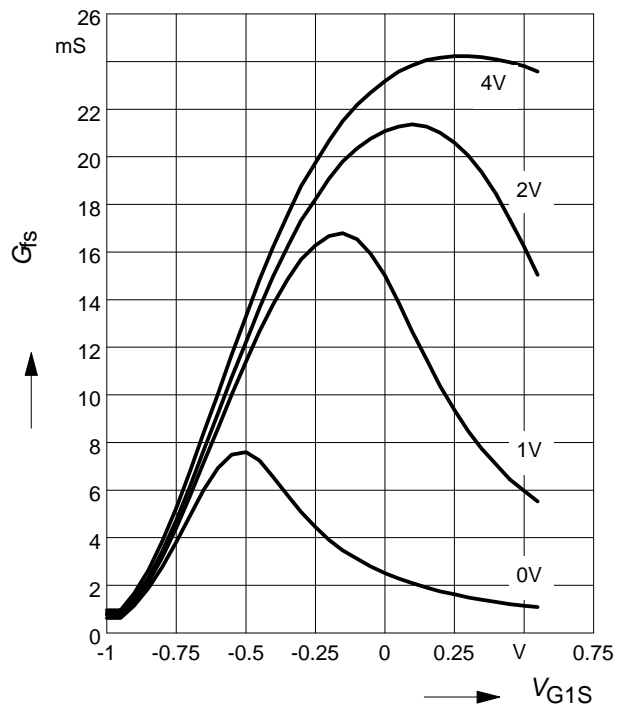
Output characteristics $I_D = f(V_{DS})$
 $V_{G2S} = 4\text{ V}$
 $V_{G1S} = \text{Parameter}$

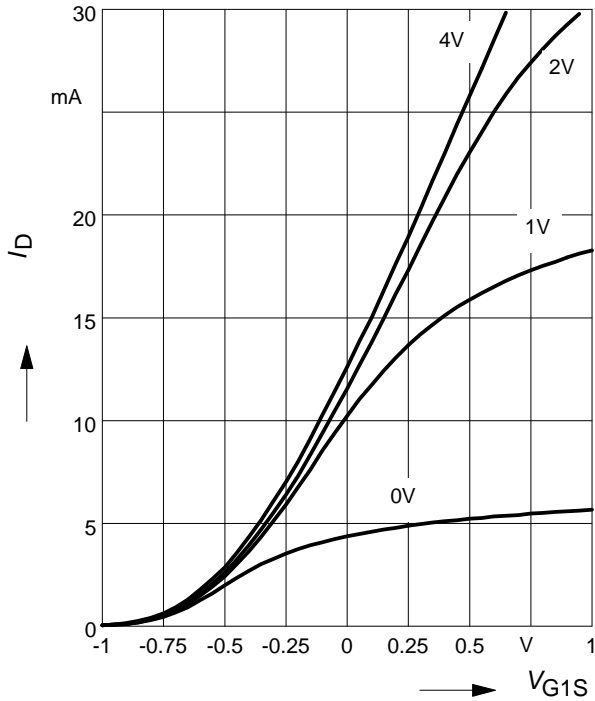
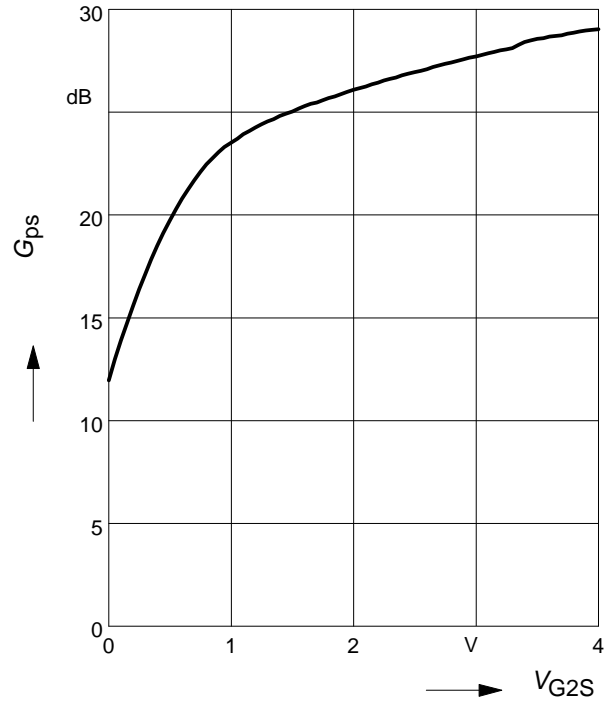
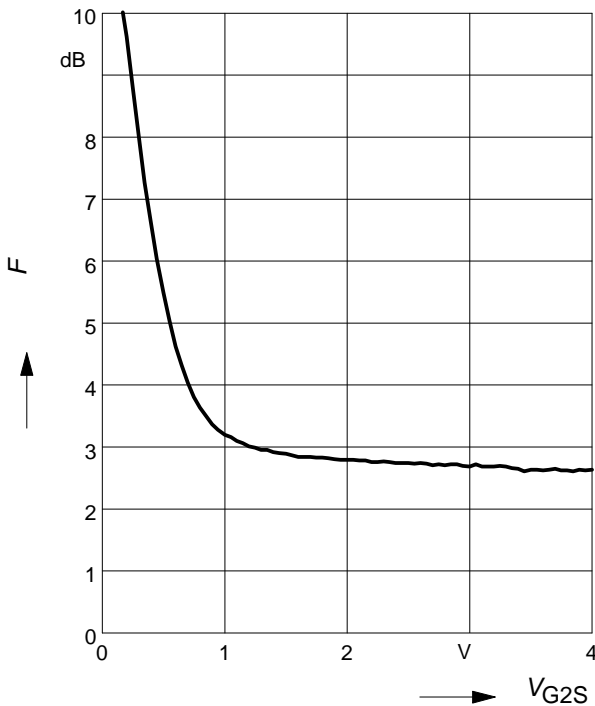
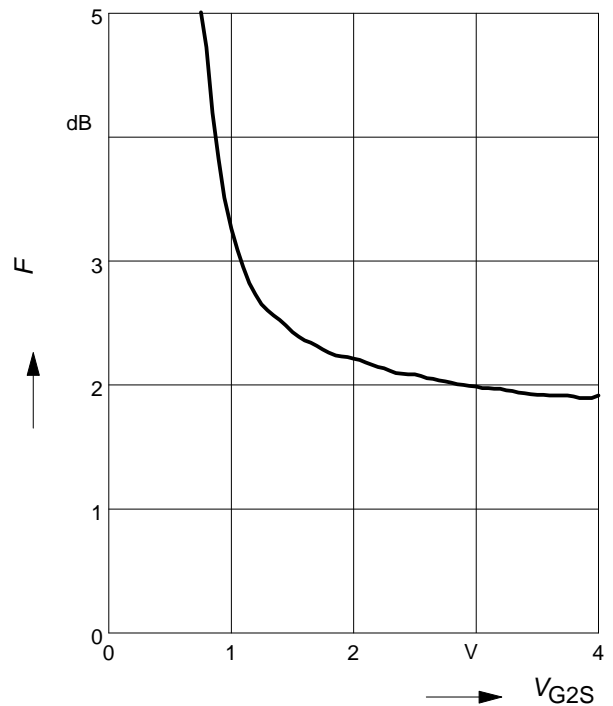
Gate 1 forward transconductance
 $g_{fs} = f(I_D)$
 $V_{DS} = 5\text{ V}, V_{G2S} = \text{Parameter}$

Gate 1 forward transconductance
 $g_{fs1} = f(V_{G1S})$

Drain current $I_D = f(V_{G1S})$
 $V_{DS} = 5V$
 $V_{G2S} = \text{Parameter}$

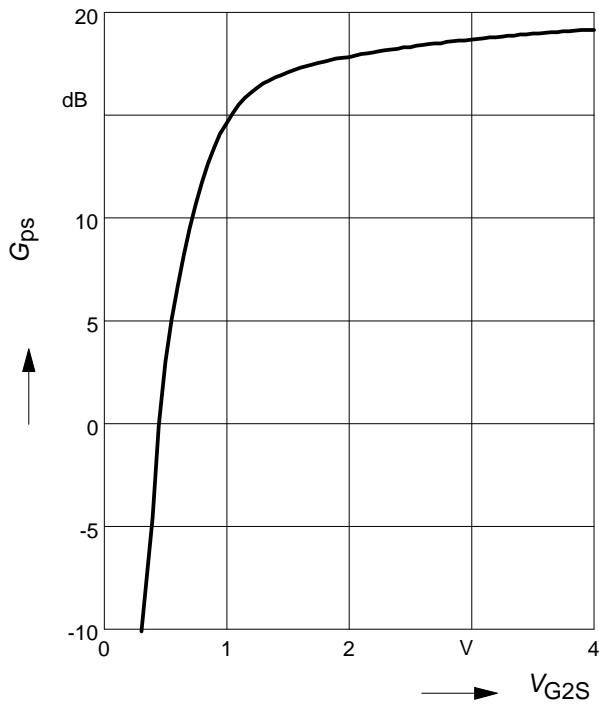
Power gain $G_{ps} = f(V_{G2S})$
 $f = 45 \text{ MHz}$

Noise figure $F = f(V_{G2S})$
 $f = 45 \text{ MHz}$

Noise figure $F = f(V_{G2S})$
 $f = 800 \text{ MHz}$

Power gain $G_{ps} = f(V_{G2S})$

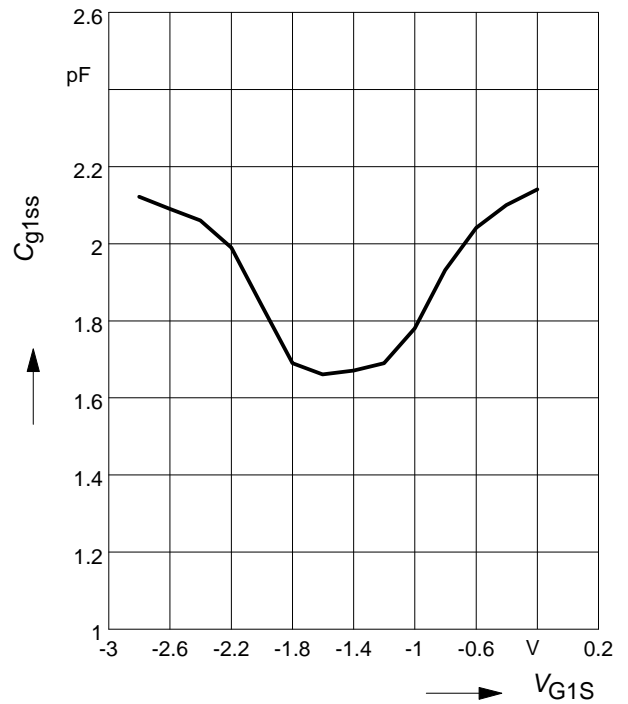
$f = 800 \text{ MHz}$



Gate 1 input capacitance $C_{g1ss} = f(V_{G1S})$



Output capacitance $C_{dss} = f(V_{DS})$

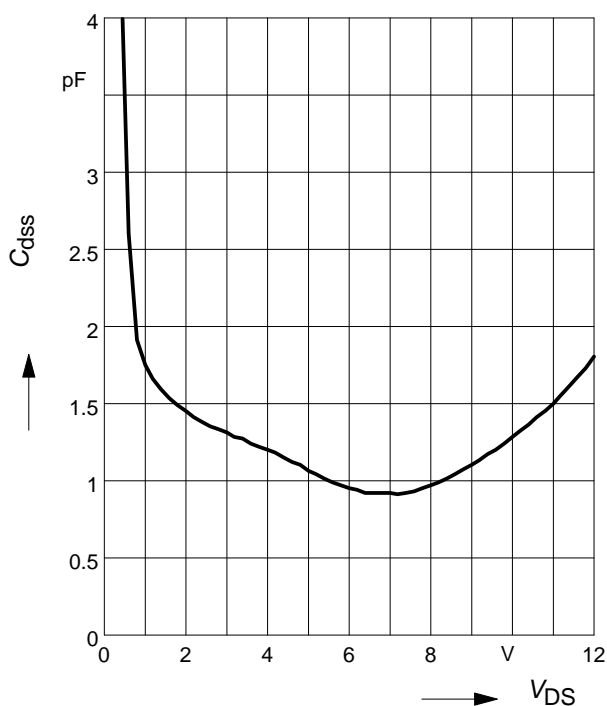

Package Outline

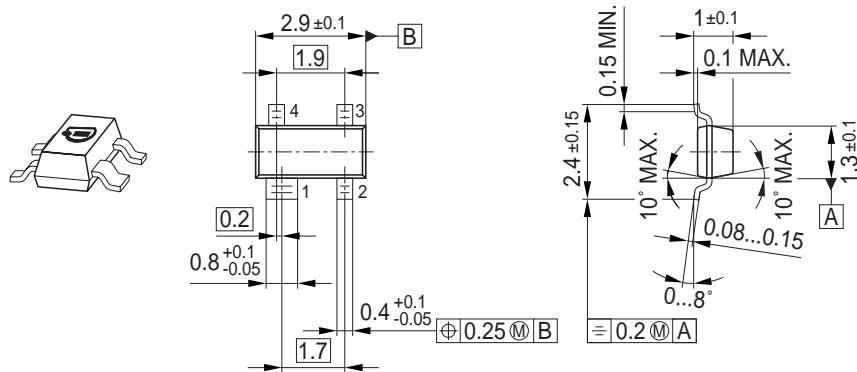

Foot Print

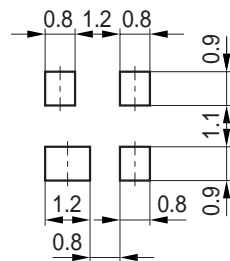

Marking Layout (Example)

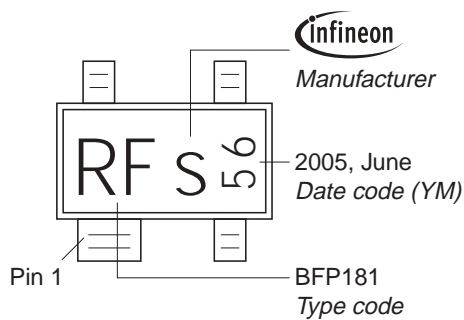

Standard Packing

Reel $\varnothing 180 \text{ mm} = 3.000 \text{ Pieces/Reel}$
 Reel $\varnothing 330 \text{ mm} = 10.000 \text{ Pieces/Reel}$

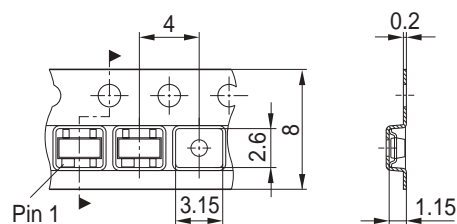

Package Outline

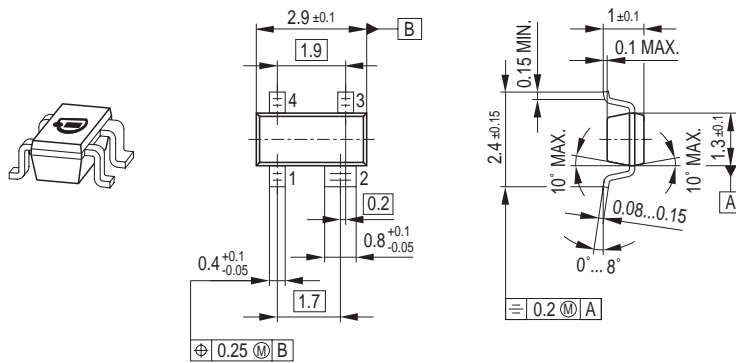

Foot Print

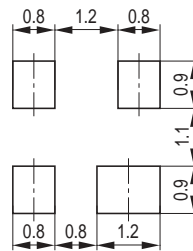

Marking Layout (Example)

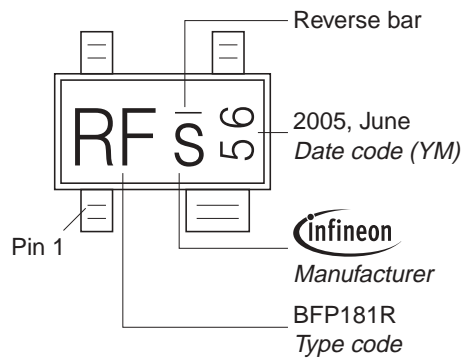

Standard Packing

Reel \varnothing 180 mm = 3.000 Pieces/Reel
 Reel \varnothing 330 mm = 10.000 Pieces/Reel

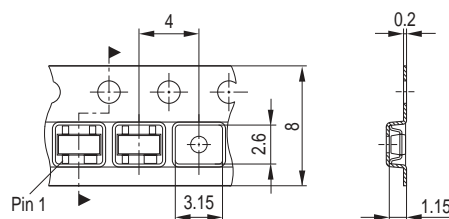

Edition 2006-02-01
Published by
Infineon Technologies AG
81726 München, Germany
© Infineon Technologies AG 2007.
All Rights Reserved.

Attention please!

The information given in this dokument shall in no event be regarded as a guarantee of conditions or characteristics ("Beschaffenheitsgarantie"). With respect to any examples or hints given herein, any typical values stated herein and/or any information regarding the application of the device, Infineon Technologies hereby disclaims any and all warranties and liabilities of any kind, including without limitation warranties of non-infringement of intellectual property rights of any third party.

Information

For further information on technology, delivery terms and conditions and prices please contact your nearest Infineon Technologies Office (www.infineon.com).

Warnings

Due to technical requirements components may contain dangerous substances. For information on the types in question please contact your nearest Infineon Technologies Office.

Infineon Technologies Components may only be used in life-support devices or systems with the express written approval of Infineon Technologies, if a failure of such components can reasonably be expected to cause the failure of that life-support device or system, or to affect the safety or effectiveness of that device or system.

Life support devices or systems are intended to be implanted in the human body, or to support and/or maintain and sustain and/or protect human life. If they fail, it is reasonable to assume that the health of the user or other persons may be endangered.

单击下面可查看定价，库存，交付和生命周期等信息

[>>Infineon Technologies\(英飞凌\)](#)

[>>点击查看相关商品](#)